

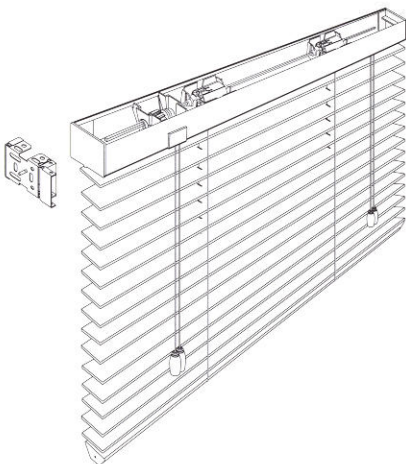

## 2" Faux Wood Blinds Color Selection Options

### Product Features

### GRABER® TRADITIONS™ 2" COMPOSITE WOOD BLINDS



- PVC polymer slats meet NFPA 701
- SureClose® headrail system
- Trapezoid shape bottomrail
- Authentic look of natural wood grain
- NoHoles™ option
- 1" and 1-1/2" cloth tapes option
- Lifetime warranty

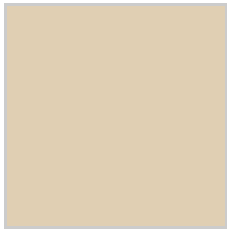

**Antique White**  
2026

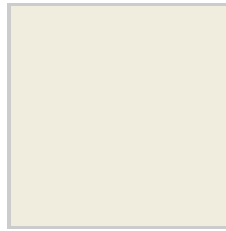

**Designer White**  
2055

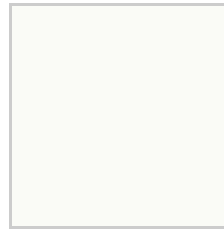

**Arctic White**  
2539

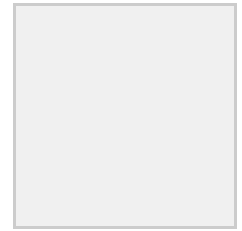

**Snowflake**  
2603



**Streaked Sandstone**

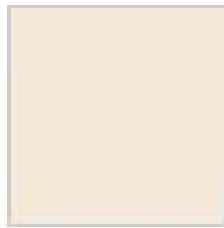

**Pure White**  
2692



**Streaked Cream**  
2715



**Streaked Prairie**  
2787

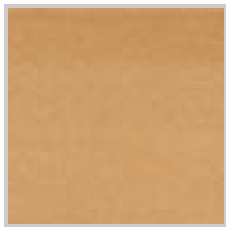

**Natural**  
5007



**White**  
5035



**Milky Way**  
5058

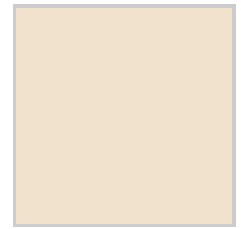

**Buttermilk**  
5078



**Sandblast Coconut**

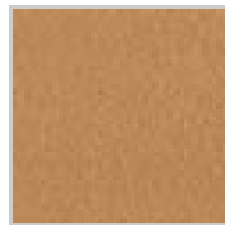

**Desert Sand**  
5625

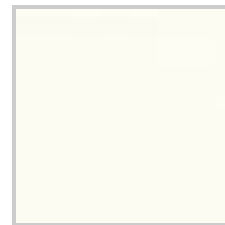

**Coconut**  
5630

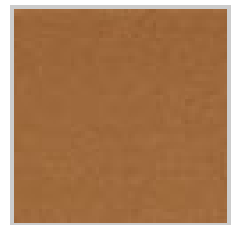

**Dark Oak**  
5709

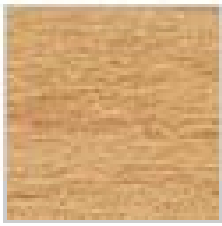

**Natural**  
2036

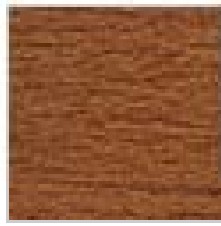

**Regal Oak**  
2038

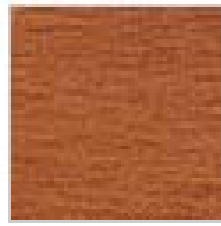

**Maple**  
2039

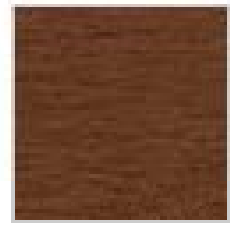

**Majestic Walnut**  
2041



**Deep Cherry**  
2316

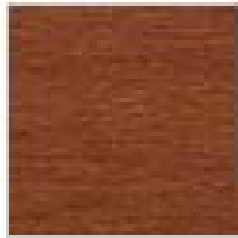

**Cognac**  
2465



**Saddle Brown**  
2694



**Wheat**  
2710



**Coffee**  
2716

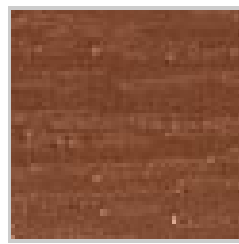

**Sandblast  
Brandy**  
5956



**Brandy**  
5736



**Sandblast  
White**  
5951



**Sandblast  
Buttermilk**  
5953



**Sandblast  
Birch**  
5954